

**Concealed two-way diverter - Chrome**











CL.1

36 200 740



- rotary diverter
- without rosette
- handle Ø 60mm

Fits: CL.1, META, CYO

	Chrome	36 200 740-00
	Brushed Platinum	36 200 740-06
	Light Gold	36 200 740-26
	Brushed Light Gold	36 200 740-27
	Brushed Durabrass (23kt Gold)	36 200 740-28
	Matte Black	36 200 740-33
	Brushed Bronze	36 200 740-42
	Brushed Champagne (22kt Gold)	36 200 740-46
	Champagne (22kt Gold)	36 200 740-47
	Brushed Dark Platinum	36 200 740-99

**Required miscellaneous**



- Concealed two-way diverter -** 35 202 970 90
- max. recess depth 160 mm
  - min. recess depth 85 mm

36 200 740

mm [inches]

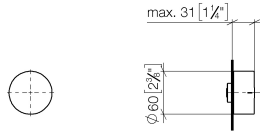

### Flow rate chart



### Certificates

LGA\_38379.

WRAS\_2307045.

36 200 740

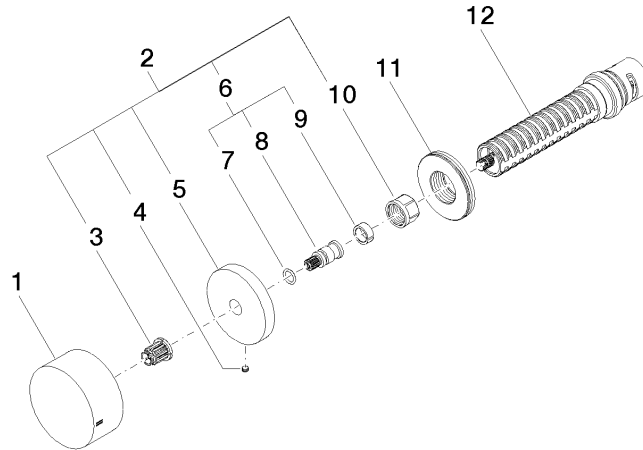

### Spare parts list

No.	Item Number	Name	Quantity used	Delivery time
1	09 20 74 044-00	handle	1	10
2	04 27 74 004 00-00	rosette	1	10
3	90 12 12 002 00 90	fixing cap	1	2
4	09 31 11 055 90	pin	1	2
5	09 27 74 004-00	rosette	1	10
6	04 29 06 020 00-00	spindle	1	10
7	90 14 10 060 00 90	seal	1	2
8	09 29 06 020-00	spindle	1	10
9	90 14 15 020 03 90	ring	1	2
10	90 23 30 023 00 90	nut	1	2
11	09 30 01 107 90	sleeve	1	2
12	90 90 03 304 10 90	diverter	1	2